



PRODUCT FEATURES

MINIMAL RECESSED HEIGHT

Width: 5.0" Height: 3.5"

ONE-PIECE EXTRUDED ALUMINUM HOUSING

Housing ensures straighter rows and consistent lens retention

MULTIPLE CEILING SYSTEMS

Engineered to be installed in multiple grid systems or hard ceiling applications

120/277VAC 0-10 VOLT DIMMING TO 1% STANDARD

UP TO 144.1 LUMENS PER WATT AT 90 CRI

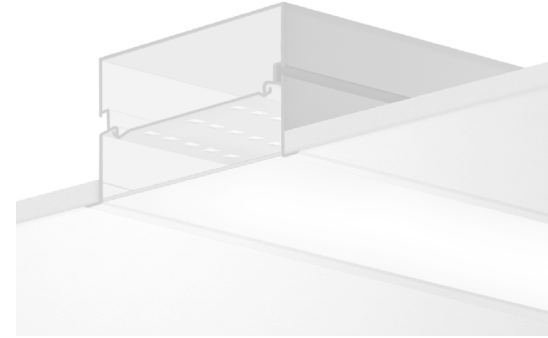

ORDERING GUIDE EX: 5R - 20 - HD - 30 - UNV - T1 - WH - C90

SERIES	LENGTH	OUTPUT	CCT	VOLTAGE	MOUNTING	FINISH
5R	XX FT	VHD 1250 LM/FT LD 500 LM/FT	30 3000K	UNV 120-277V	T1 1" T-Grid	WH White
	2' Increments EX: 20' = 20	HD 1000 LM/FT VLD 250 LM/FT	35 3500K	347 ¹ 347V	T9 9/16" T-Grid	BLK Black
		MD 750 LM/FT CD Custom	40 4000K		OF Overlapping Flange	

ORDERING NOTES

- EM NOT AVAILABLE WITH 347V.
- EM NOT AVAILABLE WITH 2' FIXTURES.
- FOR INDIVIDUAL FIXTURES, SENSOR LOCATED AT POWER FEED END. FOR RUNS, A SENSOR IS INSTALLED INTO EACH FIXTURE IN RUN, EX. 2 SENSORS ARE INSTALLED IN A 16 FT RUN (1 SENSOR IN EACH 8 FT FIXTURE)

OPTIONS

CRI	INTEGRATED CONTROLS ³	RATING	FOR INDIVIDUALS	FOR LINEAR RUNS ^{4,5}
C90				EM
C90 90 CRI	DOS Daylight Occupancy Sensor DALI DRIVER STANDARD	CP Chicago Plenum	EM ² Emergency Battery CEC LISTED	EMERGENCY BATTERY PACK QUANTITY PER RUN ⁴ POSITION IN RUN ⁵
			EC Emergency Circuit	EC
				EMERGENCY CIRCUIT QUANTITY PER RUN ⁴ POSITION IN RUN ⁵

EMERGENCY OPTION NOTES

- EM AND EC QUANTITY IS NOT TO EXCEED NUMBER OF DISCRETE FIXTURE SECTIONS IN A ROW.
- EM AND EC POSITION REFERS TO WHICH FIXTURE IN THE RUN THAT WILL BE POWERED BY THE EM/EC CIRCUIT. POSITION OPTIONS: S=STARTER, J=JOINER, E=ENDER

EX: 5R-20-HD-35-UNV-T1-WH-EM2S.J

○○○ STARTER ○○○ JOINER ○○○ ENDER ○○○

PHOTOMETRICS

5R-04-HD-35-UNV-XX-C90

Total Lumens: 4,092
Ratio: 0% Up and 100% Down
Wattage: 28.5
Efficacy: 144.0 LM/W
Fixture Length: Four Feet

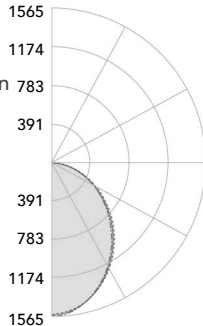

Zonal Lumen Summary

Zone	Lumens	% Fixt
0 - 30	1173.3	28.7
0 - 40	1888.1	46.1
0 - 60	3240.2	79.2
0 - 90	4091.3	100.0
90 - 180	0.6	0.0
0 - 180	4091.9	100.0

ENERGY CONSUMPTION WATTS PER LINEAR FOOT

DIRECT (LAMBERTIAN) LIGHT AT 90 CRI

	VHD:1250	HD:1000	MD:750	LD:500	VLD:250
W/FT	9.0	7.1	5.4	3.7	2.0
LM/FT	1268	1023	753	505	264
LM/W	140.9	144.1	139.4	136.5	134.7

OPERATION

Light Engine:

The 5R is available in 3000K, 3500K and 4000K CCT all within a 3-Step MacAdam Ellipse and has a standard CRI of 90+.

Optics:

The back-lit extruded acrylic lens ensures high efficiency light output, in a minimal form factor for a clean, evenly illuminated surface with minimal glare.

Electrical:

Class 2 programmable (factory pre-set) premium power supply, 120-277VAC input. Power factor >0.9. THD <15%. Integral Surge Protection to 2KV.

Dimming:

The 5R comes standard with 0-10V dimming down to 1%.

Emergency Battery Pack:

Emergency Battery Pack has been engineered to exceed UL minimum safety standards. Standard battery is CEC Listed. For most fixtures, the entire direct portion of the fixture will be illuminated by the EM Battery Pack. For 8' VHD, 10' HD and VHD, and 12' MD, HD, and VHD, only the first portion of the fixture will be illuminated by the EM battery pack. "Quantity per Run" refers to the number of fixtures in the run that will be supplied with an emergency battery pack. "Position in Run" refers to which fixture in the run that will contain the battery. Position options are Starter (S), Joiner (J), or Ender (E). For example, a 24' run needing two emergency battery packs, one in the starter and one in the joiner, would be ordered as EM2SJ. When a joiner is selected, battery packs are always supplied in 8' fixtures before 6' fixtures in that run.

Emergency Circuit:

Emergency Circuit fixtures are engineered so that the entire fixture is wired to the emergency circuit. "Quantity per Run" refers to the number of fixtures in the run that are wired to the emergency circuit. "Position in Run" refers to which fixture in the run that will be powered by the Emergency Circuit. Position options are Starter (S), Joiner (J), or Ender (E). For example, a 24' run with needing two emergency sections, one in the starter and one in the joiner, would be ordered as EC2SJ. When a joiner is selected, Emergency Circuits are always supplied in 8' fixtures before 6' fixtures in that run.

GENERAL

Warranty:

Ten (10) Year limited warranty from date of shipment.

Lumen Maintenance:

Rated for 85% initial lumen output at 90,000 Hours of operation, operated at 25°C ambient temperature; per TM-21 Guidelines published by the Illuminating Engineering Society (IES).

Certifications:

All Luminaires are UL/cUL Listed to UL 1598 Standards and approved for Indoor use in Dry/Damp Locations. Luminaires are IC rated.

MECHANICAL

Housing Construction:

Extruded Aluminum 6063-T5 alloy outer housing and LED tray with die-formed steel internal components for strength, alignment and mounting attachment. Our high-quality die-cast end caps are engineered to conceal all fasteners and to retain the sealing gaskets on the inside of the fixture while completing the clean and minimalistic look of this luminaire.

Alignment/Assembly:

The alignment system employs a four-point alignment and attachment method, designed to create straighter rows and minimize seams between sections (field assembled). Four alignment pins ensure the outer extruded aluminum rails are aligned, while a draw-screw secures housing-to-housing attachment.

Lengths:

The 5R is available in a minimum 2-foot (nominal) length with additional 2-foot increments available ($\pm 0.030"$). Longer fixture rows are available and will be configured per ALL factory specifications; typical rows are configured with 4-foot, 6-foot and 8-foot fixtures. Maximum run length on one power feed is 72'. Continuous runs over 72' will require a second feed.

Mounting Method/Hardware:

The 5R is designed for lay-in grid ceilings or "Hard" sheet rock construction. Hard ceiling installations can be supplied for overlapping flange or "Trimless" spackle flange types.

Exterior Finish:

The 5R is available in White and Black polyester powder coat finish to ensure durability.

Integrated Controls:

The 5R is available with optional integrated controls. Sensors are conveniently designed to mount in aperture. For individual fixtures, the sensor is located at the power feed end. For runs, each Starter, Joiner and Ender fixture will be supplied with a discrete sensor that will control that specific fixture within the run.

Shipping:

2-Week lead time for orders up to 1000 Linear Feet.

4-Week lead time for orders with a Black finish.

Lead time for orders greater than 1,000' will be determined at time of order.

Manufactured in the USA:

All ALL Luminaires and Components (with the exception of our LED boards and drivers) are proudly manufactured and assembled in the USA.

MOUNTING DETAILS

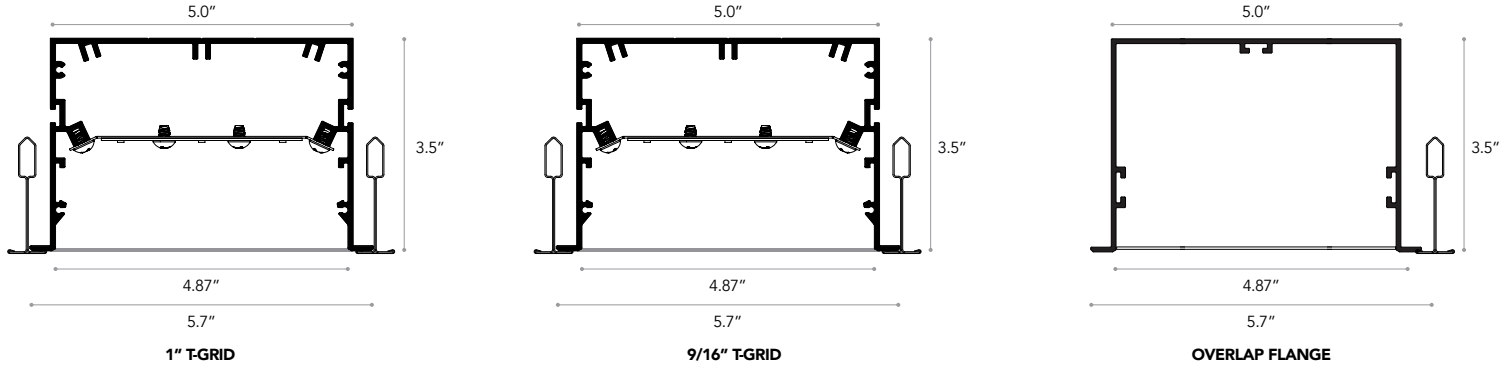

MOUNTING DETAILS NOTES

6" GRID CENTERS

FIXTURE ROW LAYOUT: SINGLE UNIT 2' - 4' - 6' - 8' - 10' - 12'

2' FIXTURE

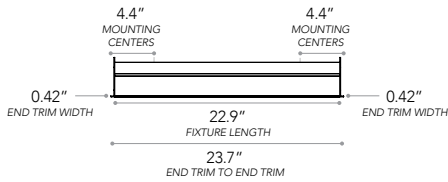

4' FIXTURE

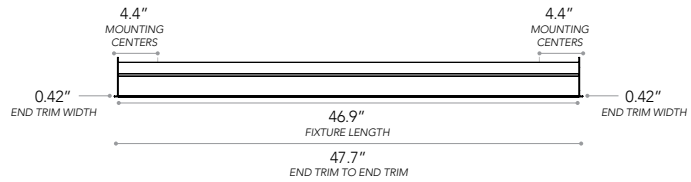

6' FIXTURE

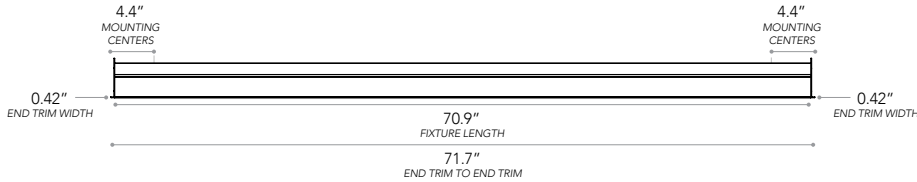

8' FIXTURE

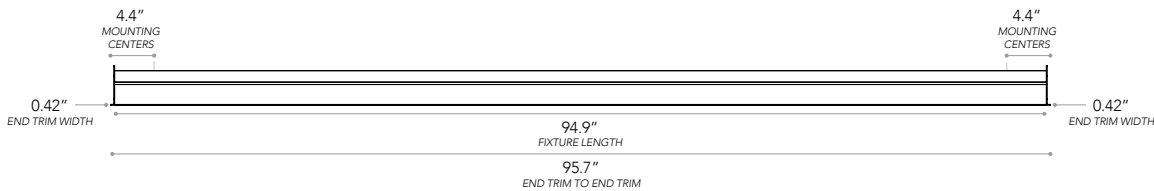

10' FIXTURE

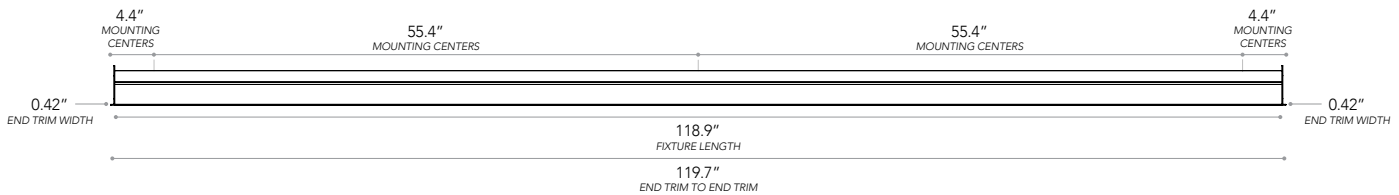

12' FIXTURE

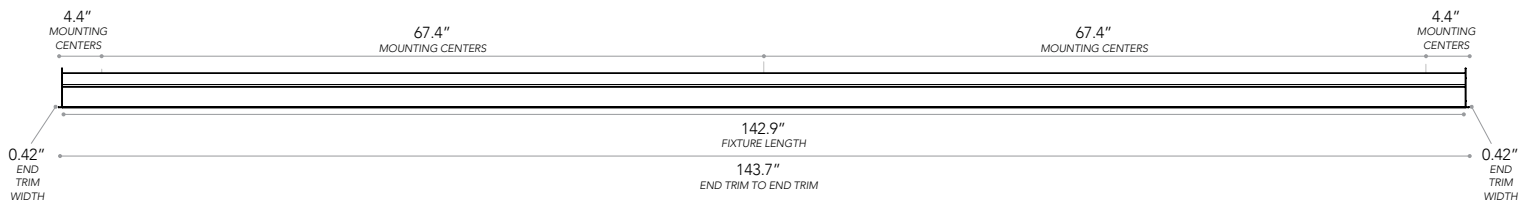

FIXTURE ROW LAYOUT: TWO UNITS 14' - 16'

14' FIXTURE

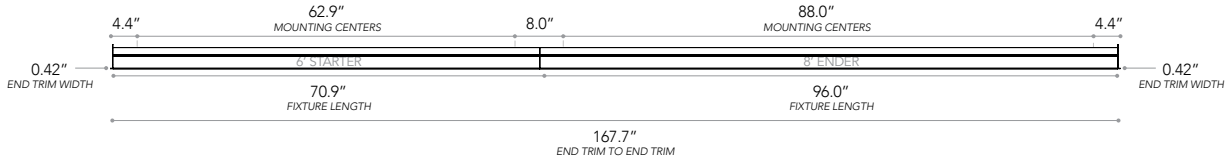

16' FIXTURE

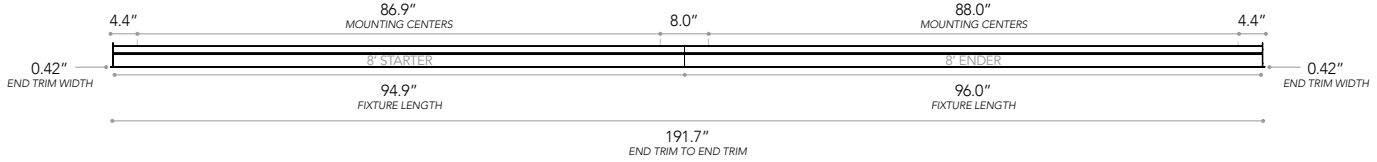

FIXTURE ROW LAYOUT: THREE UNITS 18' - 20' - 22' - 24'

18' FIXTURE



20' FIXTURE

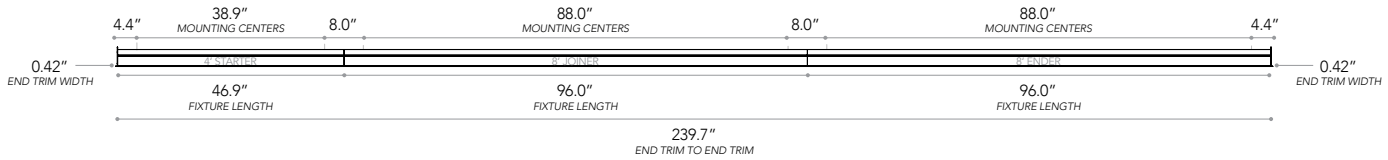

22' FIXTURE

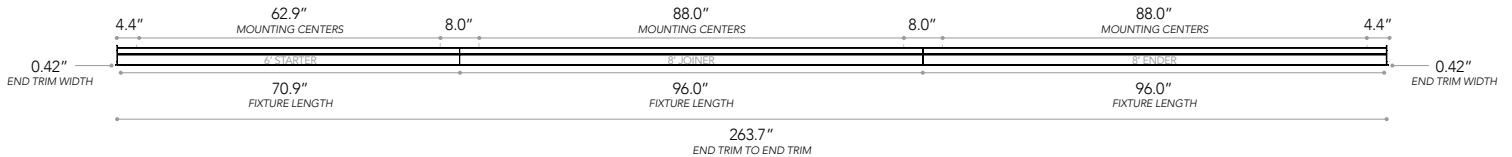

24' FIXTURE

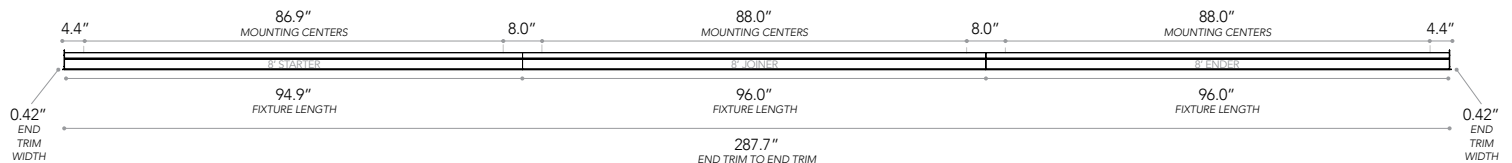

FIXTURE ROW COMPONENTS

RUN LENGTH (FT)	FIXTURE LENGTHS									JOINER KITS	CEILING CUT OUT LENGTHS
	STARTER	JOINER							ENDER		
	1	2	3	4	5	6	7	8	9		
14	6'	-	-	-	-	-	-	-	8'	1	167.25"
16	8'	-	-	-	-	-	-	-	8'	1	191.25"
18	4'	6'	-	-	-	-	-	-	8'	2	215.25"
20	4'	8'	-	-	-	-	-	-	8'	2	239.25"
22	6'	8'	-	-	-	-	-	-	8'	2	263.25"
24	8'	8'	-	-	-	-	-	-	8'	2	287.25"
26	4'	6'	8'	-	-	-	-	-	8'	3	311.25"
28	4'	8'	8'	-	-	-	-	-	8'	3	335.25"
30	6'	8'	8'	-	-	-	-	-	8'	3	359.25"
32	8'	8'	8'	-	-	-	-	-	8'	3	383.25"
34	4'	6'	8'	8'	-	-	-	-	8'	4	407.25"
36	4'	8'	8'	8'	-	-	-	-	8'	4	431.25"
38	6'	8'	8'	8'	-	-	-	-	8'	4	455.25"
40	8'	8'	8'	8'	-	-	-	-	8'	4	479.25"
42	4'	6'	8'	8'	8'	-	-	-	8'	5	503.25"
44	4'	8'	8'	8'	8'	-	-	-	8'	5	527.25"
46	6'	8'	8'	8'	8'	-	-	-	8'	5	551.25"
48	8'	8'	8'	8'	8'	-	-	-	8'	5	575.25"
50	4'	6'	8'	8'	8'	8'	-	-	8'	6	599.25"
52	4'	8'	8'	8'	8'	8'	-	-	8'	6	623.25"
54	6'	8'	8'	8'	8'	8'	-	-	8'	6	647.25"
56	8'	8'	8'	8'	8'	8'	-	-	8'	6	671.25"
58	4'	6'	8'	8'	8'	8'	8'	-	8'	7	695.25"
60	4'	8'	8'	8'	8'	8'	8'	-	8'	7	719.25"
62	6'	8'	8'	8'	8'	8'	8'	-	8'	7	743.25"
64	8'	8'	8'	8'	8'	8'	8'	-	8'	7	767.25"
66	4'	6'	8'	8'	8'	8'	8'	8'	8'	8	791.25"
68	4'	8'	8'	8'	8'	8'	8'	8'	8'	8	815.25"
70	6'	8'	8'	8'	8'	8'	8'	8'	8'	8	839.25"
72	8'	8'	8'	8'	8'	8'	8'	8'	8'	8	863.25"

FIXTURE LENGTH		
	STARTER	JOINER / ENDER
4'	46.9"	48.0"
6'	70.9"	72.0"
8'	94.9"	96.0"



OVERLAPPING FLANGE CEILING CUT OUT WIDTH

5.4"